



DTH Hammers & Bits

- DTH Hammer available for the bit with foot valve ----- PAGE 02
- DTH Hammer available for the bit without foot valve ----- PAGE 09
- DTH Bits ----- PAGE 15
- Drill Pipes ----- PAGE 22
- Adapters ----- PAGE 23
- Breakout Bench ----- PAGE 26

The Characteristics Of High Air Pressure DTH Hammer available for the bit with foot valve

It is a kind of valveless high air pressure DTH Hammer available for the bit with foot valve

It has the following characteristics:

- Valveless air distribution. More reliable.
- Simple design of the piston, long life.
- More efficient energy transfer, faster drilling speed, lower air consumption and lower oil
- Fewer internal parts, simple structure, longer life, less failure and easier to maintain because all the parts are heat treated.with it's robust& durable performance.
- Easy to disassemble because the top sub, the drive chuck and the external cylinder are connected by multi-step thread.

Code meaning of High Air Pressure DTH Hammer available for the bit With foot valve

Example:HR4-D

H—First letter of company name" Heijingang", with it's Chinese connotation reliable& steady quality

R—Code of series, "Robust" series products with robust& durable characteristic and available for the bit with foot valve

4— Hammer size 4"

D—DHD Bit shank e.g.:DHD3.5(IR3.5),DHD340A,DHD350R,DHD360,DHD380,DHD1120

Example:HR5-Q

H—First letter of company name" Heijingang", with it's Chinese connotation reliable& steady quality

R—Code of series, "Robust" series products with robust& durable characteristic and available for the bit with foot valve

5— Hammer size 5"

Q—QL Bit shank e.g.:QL30,QL40,QL50,QL60,QL80,QL120

HR3-D DTH HAMMER

HR3-D. Hammers	Item Description	Weight (Kg)	Part Number
	1 Top Sub	4.20	HR3-D-01
	2 "O"Ring of Top Sub	0.01	HR3-D-02
	3 Check Valve	0.20	HR3-D-03
	4 Spring	0.02	HR3-D-04
	5 Compression Buffer	0.10	HR3-D-05
	6 Air Distributor	1.40	HR3-D-06
	7 Internal Cylinder	1.50	HR3-D-07
	8 Piston	5.60	HR3-D-08
	9 External Cylinder	9.90	HR3-D-09
	10 "O"Ring	0.01	HR3-D-10
	11 Stop Ring	0.15	HR3-D-10
	12 Drive Chuck	1.9	HR3-D-12
	13 Drill Bit		HR3-D-13

Technical Data

Length(Less bit)	Weigth(Less bit)	External Diameter	Bit Shank	Hole Range	Connection Thread
855mm	25.0Kg	Φ82	DHD3.5 IR3.5	Φ90-Φ110	API 2 3/8 " REG
Working Pressure	Impact rate at 1.7Mpa	Recommended rotation speed	Air Consumption		
			145-350 (PSI)		
1.0-2.5Mpa	25HZ	30-70r/min	200-600 (CFM)		

HR4-D DTH HAMMER

HR4-D. Hammers	Item Description	Weight (Kg)	Part Number
	1 Top Sub	6.50	HR4-D-01
	2 "O"Ring of Top Sub	0.01	HR4-D-02
	3 Check Valve	0.35	HR4-D-03
	4 Spring	0.05	HR4-D-04
	5 Compression Buffer	0.15	HR4-D-05
	6 Air Distributor	2.10	HR4-D-06
	7 Internal Cylinder	2.25	HR4-D-07
	8 Piston	8.75	HR4-D-08
	9 External Cylinder	15.5	HR4-D-09
	10 "O"Ring	0.1	HR4-D-10
	11 Stop Ring	0.3	HR4-D-11
	12 Drive Chuck	3.40	HR4-D-12
	13 Drill Bit		HR4-D-13

Technical Data

Length(Less bit)	Weigth(Less bit)	External Diameter	Bit Shank	Hole Range	Connection Thread
915mm	39.0kg	Φ100	DHD340A Cop44	Φ110-Φ135	API 2 3/8 " REG
Working Pressure	Impact rate at 1.7Mpa	Recommended rotation speed	Air Consumption		
			145-350 (PSI)		
1.0-2.5Mpa	25HZ	30-70r/min	250-836 (CFM)		

HR5-Q DTH HAMMER

HR5-Q. Hammers	Item Description	Weight (Kg)	Part Number
	1 Top Sub	13.7	HR5-Q-01
	2 "O"Ring of Top Sub	0.01	HR5-Q-02
	3 Check Valve	0.60	HR5-Q-03
	4 Spring	0.10	HR5-Q-04
	5 Compression Buffer	0.20	HR5-Q-05
	6 Air Distributor	2.00	HR5-Q-06
	7 Internal Cylinder	2.70	HR5-Q-07
	8 Piston	13.5	HR5-Q-08
	9 External Cylinder	23.0	HR5-Q-09
	10 Guided Sleeve	2.05	HR5-Q-10
	11 Retaining Ring	0.10	HR5-Q-11
	12 Stop Ring	0.65	HR5-Q-12
	13 Drive Chuck	4.50	HR5-Q-13
	14 Drill Bit		HR5-Q-14

Technical Data

Length(Less bit)	Weigth(Less bit)	External Diameter	Bit Shank	Hole Range	Connection Thread
935mm	70.0Kg	Φ126	QL50	Φ135-Φ155	API 3 1/2 " REG
Working Pressure	Impact rate at 1.7Mpa	Recommended rotation speed	Air Consumption		
			145-350 (PSI)		
1.0-2.5Mpa	25HZ	30-70r/min	600-836 (CFM)		

HR6-Q DTH HAMMER

HR6-Q. Hammers	Item Description	Weight (Kg)	Part Number
	1 Top Sub	20.0	HR6-Q-01
	2 "O"Ring of Top Sub	0.01	HR6-Q-02
	3 Check Valve	0.70	HR6-Q-03
	4 Spring	0.10	HR6-Q-04
	5 Compression Buffer	0.25	HR6-Q-05
	6 Air Distributor	3.50	HR6-Q-06
	7 Internal Cylinder	4.20	HR6-Q-07
	8 Piston	24.5	HR6-Q-08
	9 External Cylinder	31.5	HR6-Q-09
	10 Guided Sleeve	2.50	HR6-Q-10
	11 Retaining Ring	0.10	HR6-Q-11
	12 Stop Ring	0.85	HR6-Q-12
	13 Drive Chuck	5.50	HR6-Q-13
	14 Drill Bit		HR6-Q-14

Technical Data

Length(Less bit)	Weigth(Less bit)	External Diameter	Bit Shank	Hole Range	Connection Thread
1153mm	90.0Kg	Φ148	QL60	Φ155-Φ190	API 3 1/2 " REG
Working Pressure	Impact rate at 1.7Mpa	Recommended rotation speed	Air Consumption		
			145-350 (PSI)		
1.0-2.5mpa	25HZ	30-70r/min	600-836 (CFM)		

HR8-Q DTH HAMMER

HR8-Q. Hammers	Item Description	Weight (Kg)	Part Number	
	1	Top Sub	34.0	HR8-Q-01
	2	"O"Ring of Top Sub	0.02	HR8-Q-02
	3	Check Valve	0.95	HR8-Q-03
	4	Spring	0.10	HR8-Q-04
	5	Compression Buffer	0.35	HR8-Q-05
	6	Air Distributor	6.05	HR8-Q-06
	7	Internal Cylinder	6.25	HR8-Q-07
	8	Piston	39.5	HR8-Q-08
	9	External Cylinder	57.5	HR8-Q-09
	10	Guided Sleeve	3.50	HR8-Q-10
	11	Retaining Ring	0.20	HR8-Q-11
	12	Stop Ring	1.90	HR8-Q-12
	13	Drive Chuck	13.0	HR8-Q-13
	14	Drill Bit		HR8-Q-14

Technical Data

Length(Less bit)	Weigth(Less bit)	External Diameter	Bit Shank	Hole Range	Connection Thread
1340mm	175.0Kg	Φ185	QL80	Φ195-Φ254	API 4 1/2 " REG
Working Pressure	Impact rate at 1.7Mpa	Recommended rotation speed	Air Consumption		
			145-350 (PSI)		
1.0-2.5Mpa	25HZ	30-70r/min	836-1096 (CFM)		

HR9-Q DTH HAMMER

HR9-Q. Hammers	Item Description	Weight (Kg)	Part Number
	1 Top Sub	45.5	HR9-Q-01
	2 "O"Ring of Top Sub	0.02	HR9-Q-02
	3 Breakout Ring	0.55	HR9-Q-03
	4 Check Valve	1.20	HR9-Q-04
	5 Spring	0.15	HR9-Q-05
	6 Compression Buffer	0.45	HR9-Q-06
	7 Air Distributor	10.2	HR9-Q-07
	8 Internal Cylinder	7.50	HR9-Q-08
	9 Piston	59.2	HR9-Q-09
	10 External Cylinder	79.5	HR9-Q-10
	11 Guided Sleeve	4.20	HR9-Q-11
	12 Retaining Ring	0.30	HR9-Q-12
	13 Stop Ring	2.20	HR9-Q-13
	14 Breakout Ring	0.55	HR9-Q-14
	15 Drive Chuck	23.0	HR9-Q-15
	16 Drill Bit		HR9-Q-16

Technical Data

Length(Less bit)	Weigth(Less bit)	External Diameter	Bit Shank	Hole Range	Connection Thread
1374mm	234Kg	Φ203	QL80	Φ216-Φ254	BECO 4 1/2 " REG API 4 1/2 " REG
Working Pressure	Impact rate at 1.7Mpa	Recommended rotation speed	Air Consumption		
			145-350 (PSI)		
1.0-2.5Mpa	25HZ	30-70r/min	976-1150 (CFM)		

The Characteristics Of High Air Pressure DTH Hammer available for the bit without foot valve

It is a kind of high air pressure DTH Hammer without footvalve, our newest design. It is also one of the most advanced DTH Hammers in the world.

IT HAS THE FOLLOWING CHARACTERISTICS:

- Out of the trouble of foot valve fracture and expansion and contraction.
- Lower energy consumption and higher impact frequency. The drilling speed is 15%-30% higher than the one with foot valve.
- Simple structure, reliable parts, long life, easy and cheap maintenance.
- Lower air and oil consumption. The oil consumption is about 10% lower than the one with foot valve.

Code meaning of High Air Pressure DTH Hammer available for the bit Without foot valve

Example:HK4-D

H—First letter of company name "Heijiang", with its Chinese connotation reliable & steady quality

K—Code of series, "Kangaroo" series products, with fast & agile characteristic

4— Hammer size 4"

D—DHD Bit shank e.g.:DHD3.5(IR3.5),DHD340A,DHD350R,DHD360,DHD380,DHD1120

Example:HK5-Q

H—First letter of company name "Heijiang", with its Chinese connotation reliable & steady quality

K—Code of series, "Kangaroo" series products, with fast & agile characteristic

5— Hammer size 5"

Q—QL Bit shank e.g.:QL30,QL40,QL50,QL60,QL80,QL120

HK4-D DTH HAMMER

HK4-D. Hammers	Item Description	Weight (Kg)	Part Number
----------------	------------------	-------------	-------------

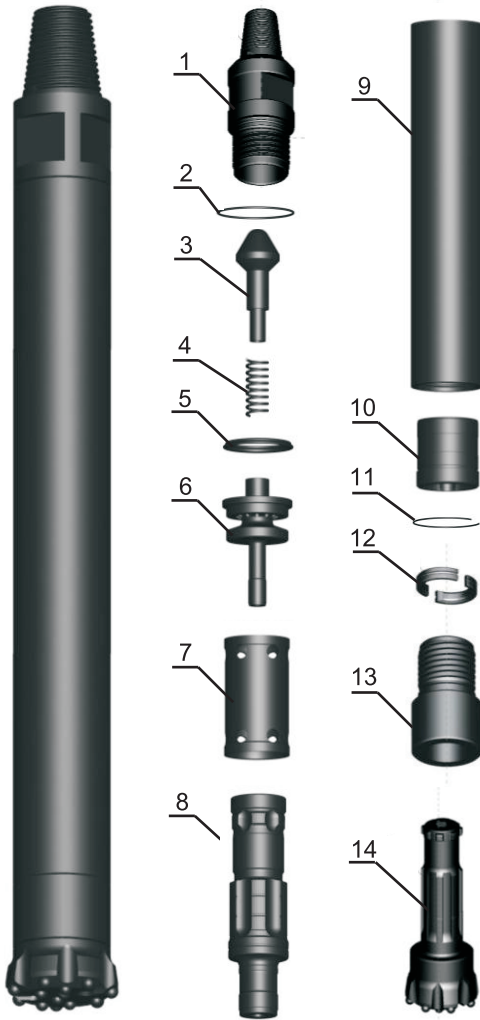

1	Top Sub	6.50	HK4-D-01
2	"O"Ring of Top Sub	0.01	HK4-D-02
3	Check Valve	0.35	HK4-D-03
4	Spring	0.05	HK4-D-04
5	Compression Buffer	0.15	HK4-D-05
6	Air Distributor	2.10	HK4-D-06
7	Internal Cylinder	2.25	HK4-D-07
8	Piston	8.50	HK4-D-08
9	External Cylinder	15.2	HK4-D-09
10	Guided Sleeve	1.30	HK4-D-10
11	"O"Ring	0.01	HK4-D-11
12	Stop Ring	0.30	HK4-D-12
13	Drive Chuck	3.40	HK4-D-13
14	Drill Bit		HK4-D-14

Technical Data

Length(Less bit)	Weighth(Less bit)	External Diameter	Bit Shank	Hole Range	Connection Thread
922mm	38.0Kg	Φ100	DHD340A Cop44	Φ110-Φ135	API 2 3/8 " REG
Working Pressure	Impact rate at 1.7Mpa	Recommended rotation speed	Air Consumption		
			145-350 (PSI)		
1.0-2.5Mpa	25HZ	30-70r/min	976-1150 (CFM)		

HK5-Q DTH HAMMER

HK5-Q. Hammers	Item Description	Weight (Kg)	Part Number
----------------	------------------	-------------	-------------

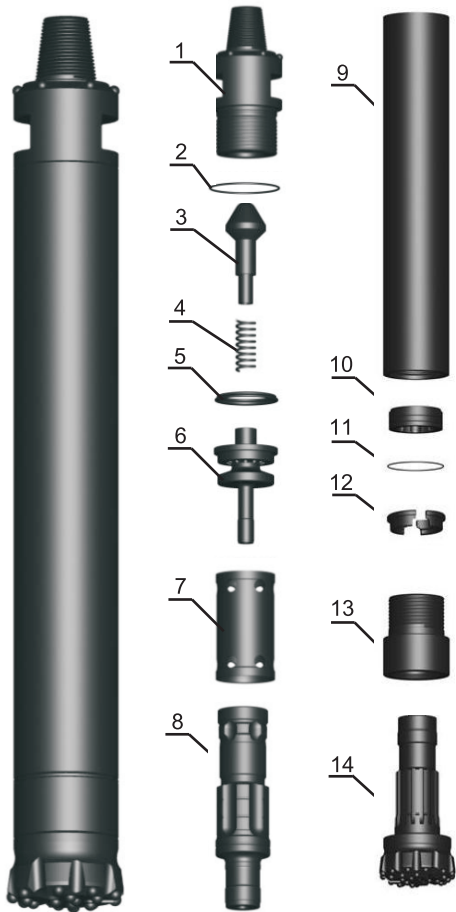

1	Top Sub	13.7	HK5-Q-01
2	"O"Ring of Top Sub	0.01	HK5-Q-02
3	Check Valve	0.60	HK5-Q-03
4	Spring	0.10	HK5-Q-04
5	Compression Buffer	0.20	HK5-Q-05
6	Air Distributor	2.00	HK5-Q-06
7	Internal Cylinder	2.70	HK5-Q-07
8	Piston	13.0	HK5-Q-08
9	External Cylinder	22.5	HK5-Q-09
10	Guided Sleeve	3.00	HK5-Q-10
11	Retaining Ring	0.10	HK5-Q-11
12	Stop Ring	0.65	HK5-Q-12
13	Drive Chuck	4.50	HK5-Q-13
14	Drill Bit		HK5-Q-14

Technical Data

Length(Less bit)	Weighth(Less bit)	External Diameter	Bit Shank	Hole Range	Connection Thread
935mm	65.0Kg	Φ126	QL50	Φ135-Φ155	API 3 1/2" REG
Working Pressure	Impact rate at 1.7Mpa	Recommended rotation speed	Air Consumption		
			145-350 (PSI)		
1.0-2.5Mpa	25HZ	30-70r/min	250-836 (CFM)		

HK6-Q DTH HAMMER

HK6-Q. Hammers	Item Description	Weight (Kg)	Part Number
	1 Top Sub	20.0	HK6-Q-01
	2 "O"Ring of Top Sub	0.01	HK6-Q-02
	3 Check Valve	0.70	HK6-Q-03
	4 Spring	0.10	HK6-Q-04
	5 Compression Buffer	0.25	HK6-Q-05
	6 Air Distributor	3.50	HK6-Q-06
	7 Internal Cylinder	4.20	HK6-Q-07
	8 Piston	23.0	HK6-Q-08
	9 External Cylinder	30.0	HK6-Q-09
	10 Guided Sleeve	4.00	HK6-Q-10
	11 Retaining Ring	0.10	HK6-Q-11
	12 Stop Ring	0.85	HK6-Q-12
	13 Drive Chuck	5.50	HK6-Q-13
	14 Drill Bit		HK6-Q-14

Technical Data

Length(Less bit)	Weigth(Less bit)	External Diameter	Bit Shank	Hole Range	Connection Thread
1153mm	85.0Kg	Φ148	QL60	Φ155-Φ203	API 3 1/2 " REG
Working Pressure	Impact rate at 1.7Mpa	Recommended rotation speed	Air Consumption		
			145-350 (PSI)		
1.0-2.5Mpa	25HZ	30-70r/min	600-836 (CFM)		

HK8-Q DTH HAMMER

HK8-Q. Hammers	Item Description	Weight (Kg)	Part Number
----------------	------------------	-------------	-------------

1	Top Sub	34.0	HK8-Q-01
2	"O"Ring of Top Sub	0.02	HK8-Q-02
3	Check Valve	0.95	HK8-Q-03
4	Spring	0.10	HK8-Q-04
5	Compression Buffer	0.35	HK8-Q-05
6	Air Distributor	6.05	HK8-Q-06
7	Internal Cylinder	6.25	HK8-Q-07
8	Piston	38.0	HK8-Q-08
9	External Cylinder	56.0	HK8-Q-09
10	Guided Sleeve	5.30	HK8-Q-10
11	Retaining Ring	0.20	HK8-Q-11
12	Stop Ring	1.90	HK8-Q-12
13	Drive Chuck	13.0	HK8-Q-13
14	Drill Bit		HK8-Q-14

Technical Data

Length(Less bit)	Weigth(Less bit)	External Diameter	Bit Shank	Hole Range	Connection Thread
1340mm	172.0Kg	Φ185	QL80	Φ195-Φ254	BECO 4 1/2" REG API 4 1/2" REG
Working Pressure	Impact rate at 1.7Mpa	Recommended rotation speed	AirConsumption		
			145-350 (PSI)		
1.0-2.5Mpa	25HZ	30-70r/min	836-1096 (CFM)		

HK9-Q DTH HAMMER

HK9-Q. Hammers	Item Description	Weight (Kg)	Part Number
----------------	------------------	-------------	-------------

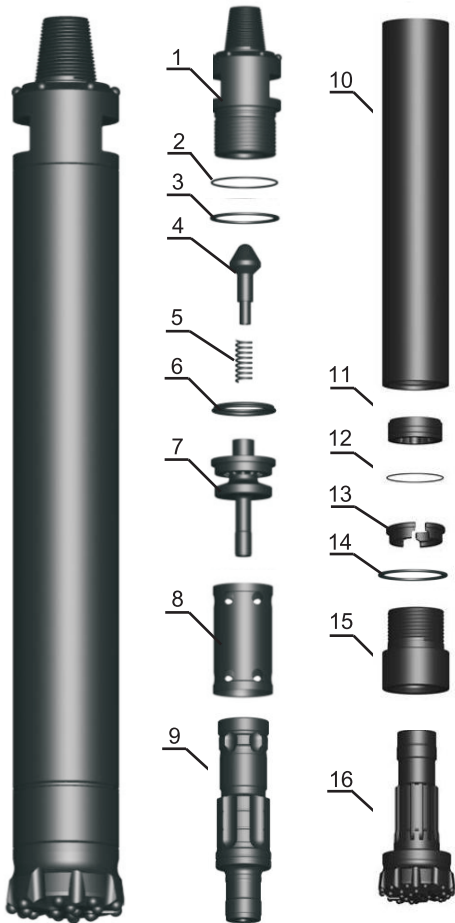

1	Top Sub	45.5	HK9-Q-01
2	"O"Ring of Top Sub	0.02	HK9-Q-02
3	Breakout Ring	0.55	HK9-Q-03
4	Check Valve	1.20	HK9-Q-04
5	Spring	0.15	HK9-Q-05
6	Compression Buffer	0.45	HK9-Q-06
7	Air Distributor	10.2	HK9-Q-07
8	Internal Cylinder	7.50	HK9-Q-08
9	Piston	50.0	HK9-Q-09
10	External Cylinder	79.5	HK9-Q-10
11	Guided Sleeve	6.20	HK9-Q-11
12	Retaining Ring	0.30	HK9-Q-12
13	Stop Ring	2.20	HK9-Q-13
14	Breakout Ring	0.55	HK9-Q-14
15	Drive Chuck	23.0	HK9-Q-15
16	Drill Bit		HK9-Q-16

Technical Data

Length(Less bit)	Weigth(Less bit)	External Diameter	Bit Shank	Hole Range	Connection Thread
1345mm	205.0Kg	Φ203mm	QL80	Φ216-Φ275	BECO 4 1/2 " REG API 4 1/2 " REG
Working Pressure	Impact rate at 2.4Mpa	Recommended rotation speed	Air Consumption		
			145-350 (PSI)		
1.0-2.5Mpa	25HZ	30-70r/min	976-1150 (CFM)		

Bit Face Shape Selection



Drop Center

For high penetration rates in soft to medium hard and fissured rock formations. Low to medium air pressures. Maximum hole deviation control.



Concave Face

The all-round application bit face specifically for medium hard and homogenous rock formations. Good hole deviation control and good flushing capacity.



Convex Face

For high penetration rates in soft to medium-hard with low to medium air pressures. It is the most resistance to steel wash, and may reduce the load and wear on the gauge buttons, but poor hole deviation control.



Double Gauge Face

This kind of face shape is suitable for fast penetration rates in medium to hard rock formations. Designed for high air pressures and good resistance to steel wash step gauge bit.



Flat Face

This kind of face shape is suitable for hard to very hard and abrasive rock formations in applications with high air pressures. Good penetration rates and resistance to steel wash.

Technical Date

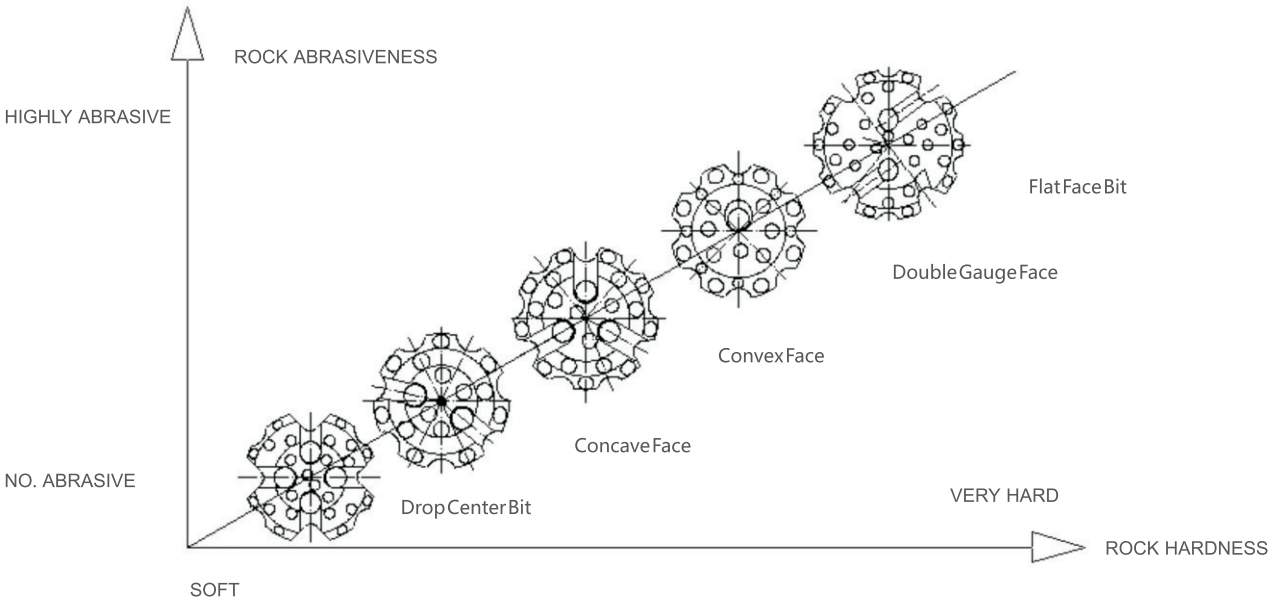

Carbide Button Shape Selection



Domed / Round Button

Domed /Round Buttons are usually used as gauge buttons of DTH Bits, suitable for very abrasive and very hard formations.

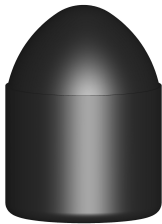

Parabolic/Semi-Ballistic Buttons

Parabolic Buttons are usually used as gauge buttons and front buttons of DTH Bits, suitable for medium abrasive and hard formations.



Ballistic Button

Ballistic Buttons are usually used as front buttons of DTH Bits, suitable for medium abrasive and medium hard formations. They can also be used as gauge buttons if the rock is soft.



Sharp Button

Sharp Buttons are usually used as front buttons of DTH bits for soft formations where fast penetration rates are possible and button breakage is minimal.



Flat Button

Flat buttons are usually used as protection buttons to reduce wear on rubbing surfaces of DTH Bits.

3" BIT Data Referenced By IR3.5 Flat Face Bit

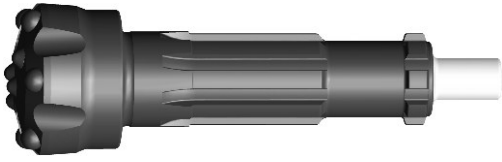

★ Specification Of Products : IR3.5

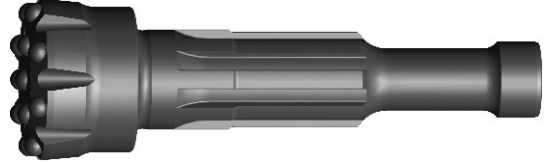

Specification Of Products : M30



Specification Of Products : COP32

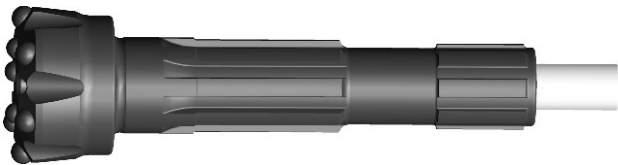

Specification Of Products : QL30, COP34

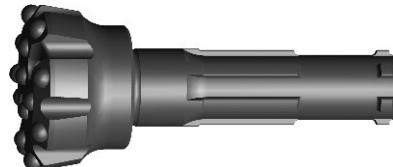

Specification Of Products : BR3

Diameter		No x Button diameter , mm		Button angle°	Flushing holes	Weight (Kg)	Part No
mm	inch	Gauge Buttons	Front Buttons				
90	3 9/16	8x12	7x11	38	2	4.6	HD35-90
92	3 5/8	8x12	7x11	38	2	4.6	HD35-92
95	3 3/4	8x12	7x11	38	2	4.7	HD35-95
100	3 15/16	8x12	7x12	38	2	4.8	HD35-100
105	4 1/8	8x14	7x12	38	2	5.0	HD35-105
110	4 5/16	8x14	7x12	38	2	5.5	HD35-110

4" BIT Data Referenced By DHD340A Flat Face Bit

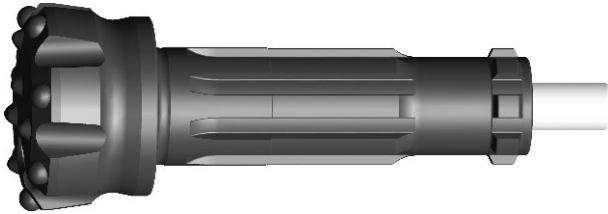

★ Specification Of Products : DHD340A
COP44



Specification Of Products : M40



Specification Of Products : SD4

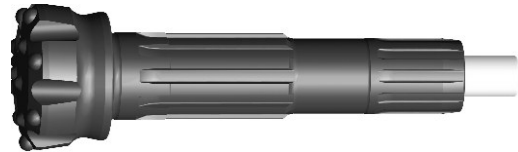

Specification Of Products : QL40

Diameter		No x Button diameter , mm		Button angle°	Flushing holes	Weight (Kg)	Part No
mm	inch	Gauge Buttons	Front Buttons				
105	4 1/8	8x14	7x12	38	2	7.6	HD45-105
110	4 5/16	8x14	7x12	38	2	7.8	HD45-110
115	4 1/2	8x14	7x13	38	2	8.2	HD45-115
120	4 3/4	8x14	8x13	38	2	8.7	HD45-120
125	4 15/16	8x14	10x13	38	2	8.9	HD45-125
130	5 1/8	8x16	8x14	38	2	9.4	HD45-130

5" BIT Data Referenced By DHD350R Flat Face Bit



★ Specification Of Products : DHD350R
COP54



Specification Of Products : M50

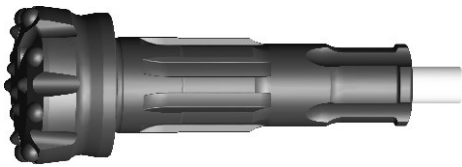

Specification Of Products : SD5



Specification Of Products : QL50

Diameter		No x Button diameter , mm		Button angle°	Flushing holes	Weight (Kg)	Part No
mm	inch	Gauge Buttons	Front Buttons				
130	5 1/8	8x16	8x14	38	2	15	HD55-130
135	5 1/4	8x16	8x14	38	2	15.2	HD55-135
138	5 1/2	8x16	10x14	38	2	15.6	HD55-138
140	5 1/2	8x16	10x14	38	2	15.8	HD55-140
146	5 3/4	8x18	8x15	38	2	16.1	HD55-146
150	5 7/8	8x18	8x15	38	2	16.5	HD55-150
152	6	8x18	8x15	38	2	17	HD55-152
156	6 1/8	8x18	8x16	38	2	17.5	HD55-156

6" BIT Data Referenced By DHD360R Concave Face Bit

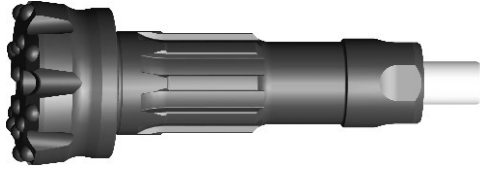

★ Specification Of Products : DHD360
COP64



Specification Of Products : M60

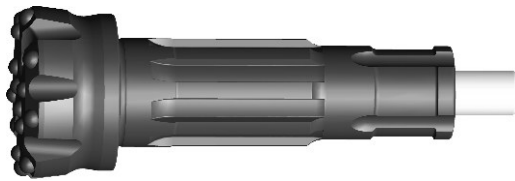

Specification Of Products : SD6



Specification Of Products : QL60

Diameter		No x Button diameter , mm		Button angle°	Flushing holes	Weight (Kg)	Part No
mm	inch	Gauge Buttons	Front Buttons				
152	6	8x18	4x16+4x14	38	2	23	HD65-152
154	6	8x18	4x16+4x14	38	2	23	HD65-154
156	6 1/4	8x18	4x16+4x14	38	2	23	HD65-156
159	6 1/4	8x18	4x16+4x14	38	2	23.5	HD65-159
165	6 1/2	8x18	8x16	38	2	24	HD65-165
171	6 3/4	8x18	8x16	38	2	25	HD65-171
178	7	8x18	10x16	38	2	26	HD65-178
185	7 1/4	8x18	10x16	38	2	26.8	HD65-185
190	7 1/2	10x18	13x16	38	2	27.5	HD65-190
203	8	10x18	8x18+6x16	38	2	31	HD65-203

8" BIT Data Referenced By DHD380 Concave Face Bit

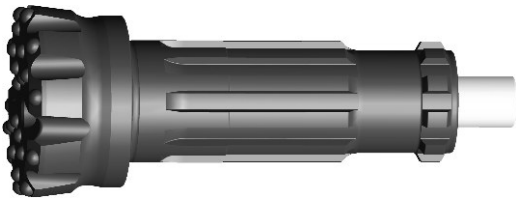

★ Specification Of Products : DHD380
COP84



Specification Of Products : M80

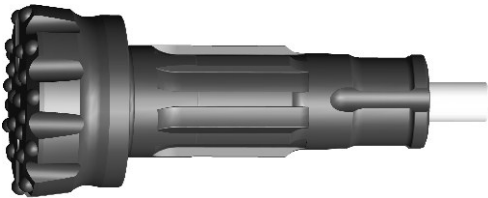

Specification Of Products : SD8

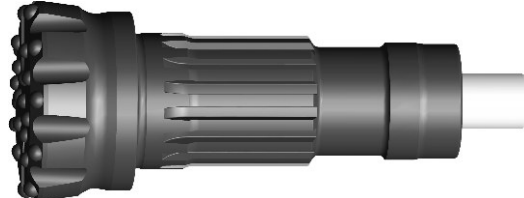

Specification Of Products : QL80

Diameter		No x Button diameter , mm		Button angle°	Flushing holes	Weight (Kg)	Part No
mm	inch	Gauge Buttons	Front Buttons				
200	7 7/8	10x18	8x18+6x16	38	2	46	HD85-200
203	8	10x18	8x18+6x16	38	2	47	HD85-203
216	8 1/2	10x18	8x18+6x16	38	2	53	HD85-216
219	8 5/8	10x18	8x18+6x16	38	2	54	HD85-219
222	8 3/4	10x18	8x18+6x16	38	2	55	HD85-222
225	8 7/8	10x18	8x18+7x16	38	2	56	HD85-225
229	9	10x18	8x18+7x16	38	2	57	HD85-229
235	9 1/4	12x18	30x16	38	2	57.5	HD85-235
240	9 1/2	12x18	30x16	38	2	58	HD85-240
254	10	12x18	12x18+8x16	38	2	61	HD85-254
270	10 5/8	12x19	20x18+8x16	38	2	66	HD85-270
279	11	12x19	20x18+9x16	38	3	71	HD85-279

Drill Pipe

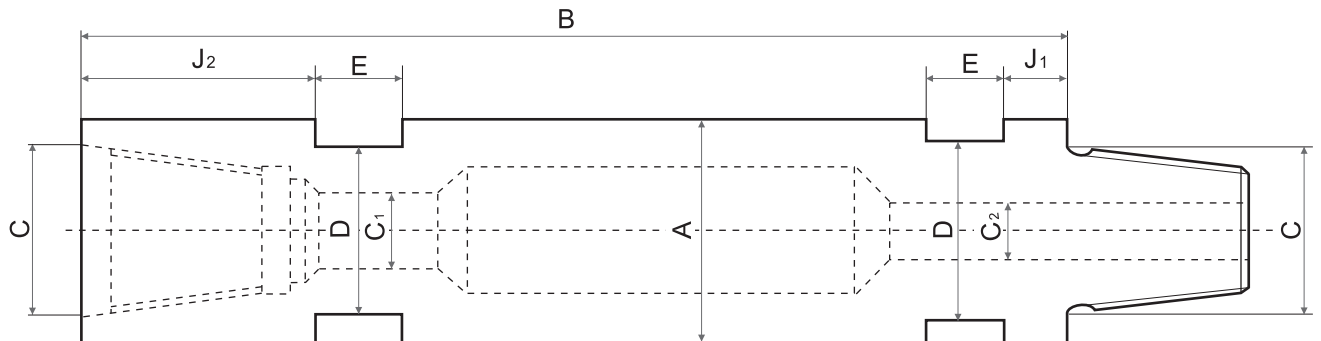

A OD(mm)	C C Tool Joints		J Length shoulder to flat		D Across Flat (mm)	Allowed pull down (kNm)	Approx Weight (3m long/kgs)	E Width spanner flat (mm)	
	Connection	C1	C2	J1					J2
Φ76	API 2 3/8"REG	25.4	38.1	16	90.5	65	5.4	26.6	38.1
Φ89	API 2 3/8"REG	28.6	38.1	11.1	76.2	69.8	11.2	53.4	60.3
Φ102	API 3 1/2"REG	44.4	57.1	15.8	90.5	63.5	14.2	53.1	50.8
Φ114	API 3 1/2"REG	38.1	57.1	15.8	69.8	92.2	22.2	77.4	69.8
Φ127	API 3 1/2"REG	44.4	57.1	12.7	95.2	120.6	47	114	50.8s
Φ140	API 3 1/2"REG	44.4	57.1	12.7	95.2	120.6	47	114	50.8
Φ152	API 4 1/2"REG	76.2	85.7	19	120.6	130.1	52.9	127	60.3

Box-Box Adapters

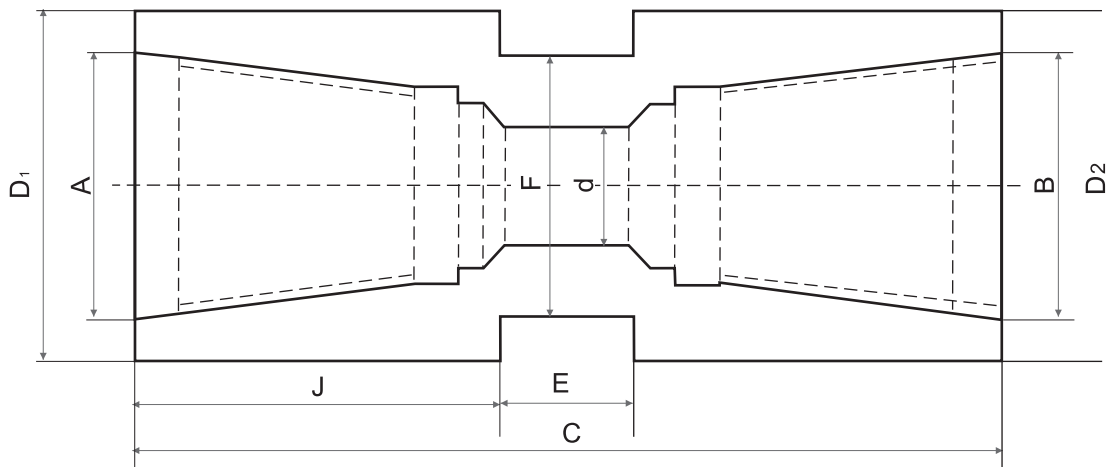

Connection		C Length (mm)	J Length Shoulder (mm)	E Width spanner flats (mm)	d Std Bore (mm)	Outside Diameter		F Across Flat (mm)
Box Up A	Box Down B					Top D1(mm)	Bottom D2(mm)	
API 2 3/8"REG	API 2 3/8" REG	219	57.1	50.8	38.1	88.9	88.9	69.85
API 2 7/8"REG	API 2 3/8" REG	219	69.85	50.8	38.1	114.3	88.9	98.4
API 2 3/8"REG	API 3 1/2" REG	128.6	57.1	50.8	38.1	88.9	114.3	69.8
API 3 1/2"REG	API 3 1/2" REG	241.3	69.85	50.8	44.45	114.3	114.3	98.4
API 3 1/2"REG	API 4 1/2" REG	269.8	88.9	50.8	58.7	114.3	146	98.4
API 2 7/8"REG	API 3 1/2" REG	241.3	69.85	50.8	44.45	114.3	51.7	98.4
API 4 1/2"REG	API 2 7/8" REG	250.8	76.2	50.8	44.45	114.3	146	98.4

Pin-Box Adapters

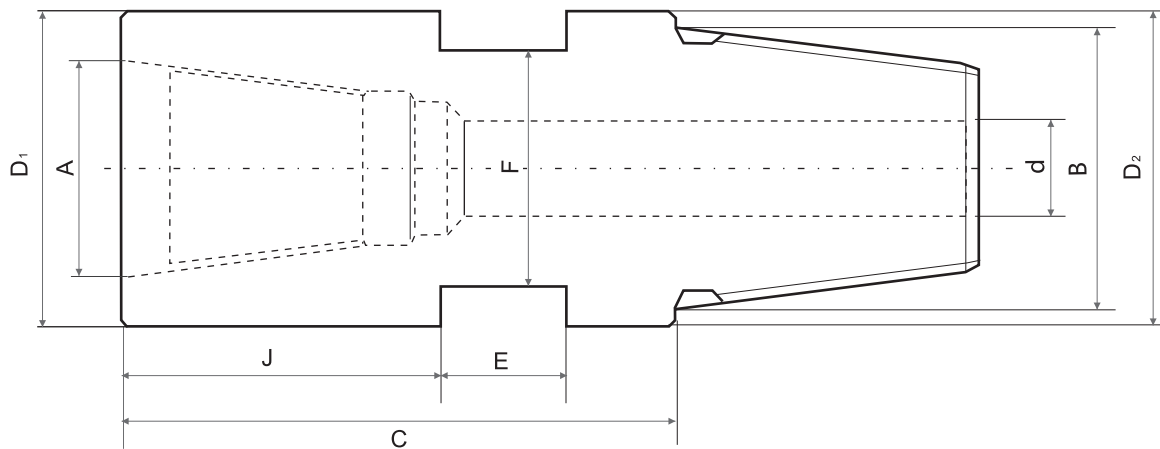

Connection		C Length (mm)	J Length Shoulder (mm)	E Width spanner flats (mm)	d Std Bore (mm)	Outside Diameter		F Across Flat F (mm)
Box Up A	Pin Down B					Top D1(mm)	Bottom D2(mm)	
API 2 3/8"REG	API 2 3/8"REG	140	50.8	65	24	88.9	88.9	69.85
API 2 3/8"REG	API 2 7/8"REG	134.9	69.85	50.8	31.75	88.9	88.9	69.85
API 2 3/8"REG	API 3 1/2"REG	146	39.7	50.8	25.4	114.3	88.9	98.4
API 3 1/2"REG	API 3 1/2"REG	101.6	39.7	50.8	44.45	127	127	98.4
API 3 1/2"REG	API 4 1/2"REG	134.9	39.7	50.8	52.4	114.3	146	98.4
API 2 7/8"REG	API 2 3/8"REG	134.9	39.7	50.8	31.75	88.9	88.9	69.85
API 2 7/8"REG	API 3 1/2"REG	134.9	39.7	50.8	44.45	114.3	114.3	98.4
API 2 7/8"REG	API 4 1/2"REG	174.6	100	50.8	44.45	114.3	146	98.4

Pin-Pin Adapters

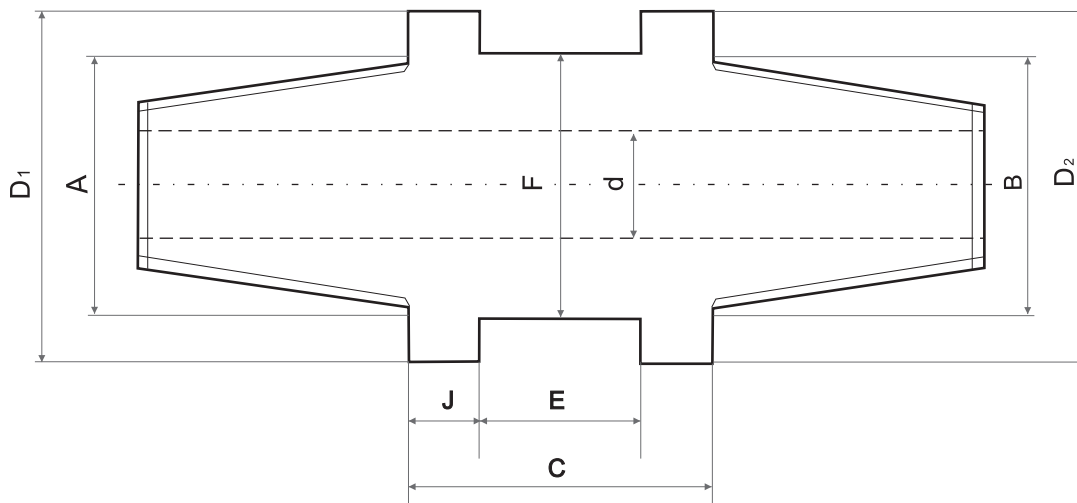

Connection		C Length (mm)	J Length shoulder (mm)	E Width spanner flats (mm)	d Std bore (mm)	Outside diameter		F Across flat (mm)
Pin up A	Pin up B					Top D1(mm)	Bottom D2(mm)	
API 2 3/8"REG	API 2 3/8" REG	70	20	50.8	24	78	78	65
API 2 3/8"REG	API 2 7/8" REG	152.4	50.8	50.8	25.4	88.9	88.9	69.85
API 2 3/8"REG	API 3 1/2" REG	96	35	50.8	24	114.3	114.3	98.4
API 3 1/2"REG	API 3 1/2" REG	177.8	63.5	50.8	44.45	114.3	114.3	98.4
API 3 1/2"REG	API 4 1/2" REG	92	12.7	69.85	38.1	114.3	139.7	120.65
API 4 1/2"REG	API 4 1/2" REG	203.2	76.2	50.8	58.7	146	146	120.65

Breakout Bench

Available for hammer size 6"~12"



Technical Data: rpm of chain less than 10tums/m velocity of piston rod 1.8meter/m

Hammer Range	Overall dimensions (length*width*depth)	Weight	Maximum assembly torque
3.5"-10"	1600*930*1050mm	800Kg	67 KN*m(50ftlb)
Maximum disassembly torque	Operating Height	Hydraulic Range	Power
81 KN*m(60ftlb)	800mm	0-20Mpa	3Kw,220V,50Hz